

# Keysight Technologies

## Power-Consumption Measurements for LTE User Equipment

### Application Note

If you are designing smartphone chipsets or operating a mobile network, you need to determine how certain parameters affect a specific smartphone's power consumption and figure out how to adjust the parameters to improve battery life. In this application note we show how to use the Keysight Technologies, Inc. E6621A PXT wireless communications test set and the Keysight N6705B DC power analyzer to establish a power consumption model for LTE user equipment (UE). The model is useful when you need to examine the UE battery life in system-level simulations.

We will explain how the Keysight equipment can be used in manual tests, but we do not discuss how to make automated tests (for example, using VEE software).

In this application note, we analyze smartphones adhering to the 3GPP LTE standard [1].

## Introduction

Modern smartphones have limited battery life, and this affects user satisfaction. Chipset manufacturers and mobile network operators will want to evaluate a smartphone's power consumption in a realistic setup and establish a power consumption model based on the evaluation. The model helps you determine how certain parameters affect a specific smartphone's power consumption and how you can adjust the parameters to improve battery life.

The key parameters are uplink (UL) and downlink (DL) data rates ( $R$ ), transmit (Tx) and receive (Rx) power levels ( $S$ ), cell bandwidth ( $BW$ ), and discontinuous reception (DRX). The parameters affect the smartphone's modem, and more specifically, the Rx and Tx base band (BB) and Rx and Tx radio frequency (RF) components. A power consumption model that includes these components has been proposed in an article entitled *Empirical LTE Smartphone Power Model with DRX Operation for System Level Simulations* [2]. It covers the contribution from each parameter on the related component, as illustrated in Figure 1.

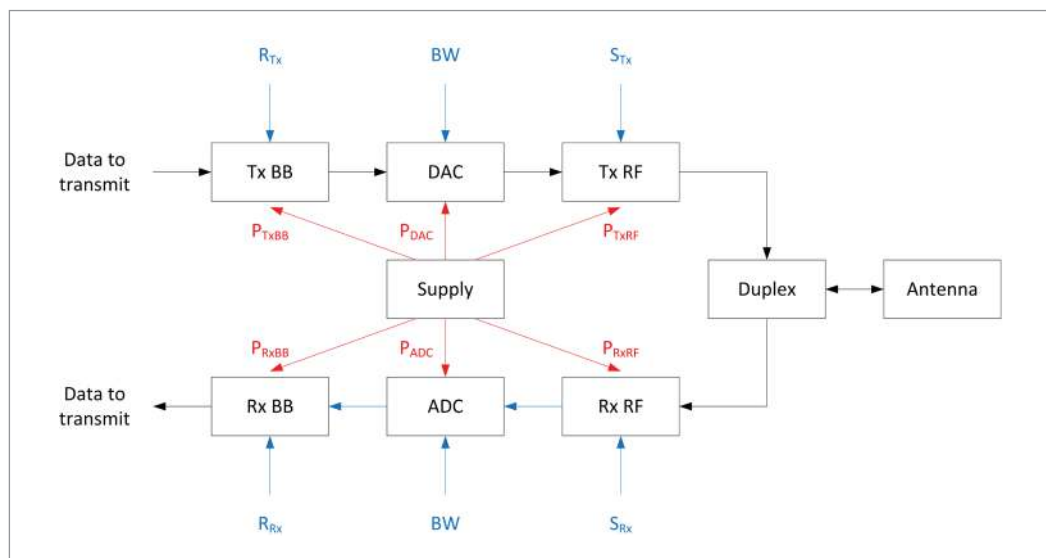

Figure 1. UE power consumption model, based on Figure 1 in [2]

The model is made by measuring how each parameter affects the power consumption, but the model does so by capturing major trends and not implementation-specific peculiarities.

## Setup description

The measurements were performed in the laboratory using the Keysight E6621A PXT wireless communications test set [3] and the N6705B DC power analyzer [4] with the N6781A 2-quadrant source/measure unit [5] module installed.

The UE is connected to

- the PXT using the internal antenna connectors of the UE
- the N6705B by use of the UE battery terminal connectors (the battery is removed)

The setup is sketched in Figure 2, and a photo of the physical setup is shown in Figure 3.

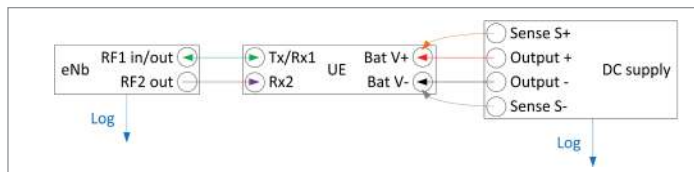

Figure 2. Measurement setup

The 4-wire sense option of the N6781A is used to maintain a stable supply voltage at the UE battery terminal.

You can enable the sense option in the **Advanced** menu of the **Source Settings** menu. Choose either **Local** or **4 wire**. The latter allows you to sense the voltage at the battery connectors.

## Proposed list of measurements

The goal is to estimate how the Rx and Tx BB and RF components contribute to the total modem power consumption. This goal is achieved by varying one key parameter, for example DL data rate for Rx BB examination, while keeping other parameters constant. Table 1 contains the test cases. The varied parameter of each test is marked with brackets.

Before you make the measurements, you need to decide on a frequency band and a cell bandwidth and set up the PXT accordingly. The frequency band and the cell bandwidth must obviously be supported by the UE. The choice of frequency band will affect the RF power consumption and in particular the Tx power amplifier [8] while the cell bandwidth will determine the upper limit of the achievable data rate.

Other interesting measurements include power consumption as a function of screen brightness and power consumption as a function of CPU/GPU load. The PXT has a DRX mode, so you can examine the DRX sleep mode power of capable phones. Important parameters include DRX long period, DRX inactivity timer and DRX on duration [2, 6].

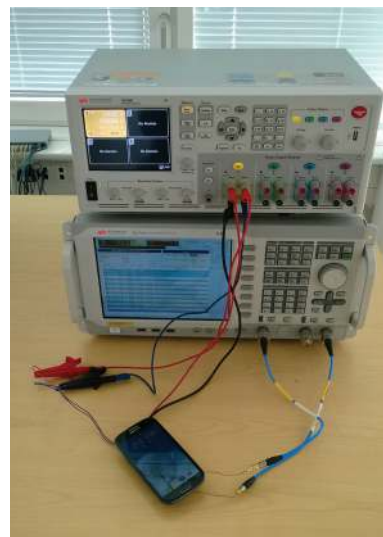

Figure 3. Physical measurement setup using the PXT (bottom) and N6705B (top)

Table 1. Measurements on key parameters, based on Table 2 in [2]

| Test case | Downlink parameters          |                         |                     | Uplink parameters            |                         |                      |           |
|-----------|------------------------------|-------------------------|---------------------|------------------------------|-------------------------|----------------------|-----------|
|           | Modulation and coding scheme | Physical resource block | Receive power level | Modulation and coding scheme | Physical resource block | Transmit power level |           |
| Rx BB     | 1                            | [0, 28]                 | 100                 | -25                          | 6                       | 100                  | -40       |
|           | 2                            | 0                       | [0, 100]            | -25                          | 6                       | 100                  | -40       |
| Rx RF     | 3                            | 0                       | 100                 | [-25, -90]                   | 6                       | 100                  | -40       |
| Tx BB     | 4                            | 0                       | 3                   | -25                          | 6                       | [0, 100]             | -40       |
|           | 5                            | 0                       | 3                   | -25                          | [0, 23]                 | 100                  | -40       |
| Tx RF     | 6                            | 0                       | 3                   | -25                          | 6                       | 100                  | [-40, 23] |

## Procedure

In this section, we outline the procedure for performing a UE power consumption measurement. You can make the measurement manually using the control/button interface of the PXT and N6705B or automatically using Keysight VEE programming and a PC connected to the equipment via LAN.

The steps for a manual measurement are:

1. Set up the N6705B mainframe and N6781A SMU module
2. Set up the PXT according to the test case in Table 1
3. Initiate the measurement
4. Run the data logging tool in the N6705B and note important PXT values (data rate, power level, and so forth)

### Step 1: Setting up the N6705B mainframe and N6781A SMU module

First, you must determine the appropriate battery voltage level (typically 3.7 to 3.8 V) and set the voltage and maximum current in the N6705B. Next, configure the data logger properties – Duration, Sample Period and File Name – as illustrated in Figure 4. Start the log by pressing **Run/stop** in the **Data logger** menu.

Note that the N6781A option offers multiple ways to connect the UE, even including the battery [5].

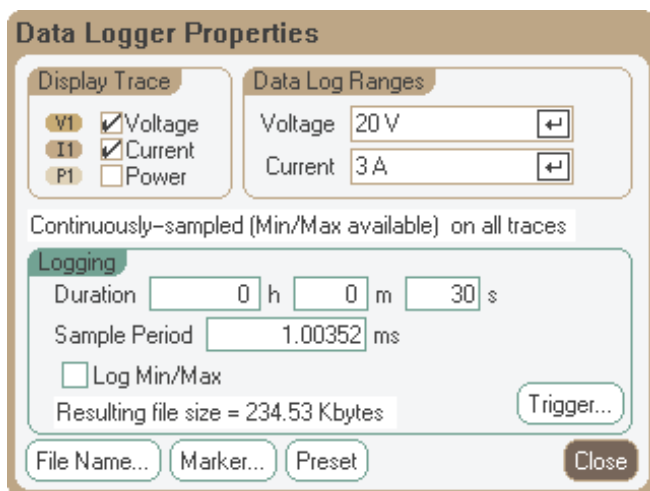

Figure 4. Data logger properties on the N6705B

### Step 2: Setting up the PXT

The PXT setup involves adjusting many parameters, so after you have set the initial parameters (such as cell bandwidth, carrier frequency and so forth), it can be beneficial to save the setup to a scenario file.

After loading the scenario file, adjust the physical (PHY) layer settings. The **PHY Settings** menu has submenus for adjusting downlink and uplink settings. In each submenu, you can set the modulation and coding scheme (MCS) and the number of physical resource blocks (PRBs). As shown in Table 1, these two parameters are varied when you examine BB power consumption. The parameters have a direct effect on data rate, which affects the BB processing and power consumption.

In the same submenu, you will see an option for **Resource Allocation Mode**. This mode lets you schedule DL and UL data on the PDSCH and PUSCH. In **Auto** mode, the PXT will schedule data if another entity within the PXT is generating it. This could be, for example, the dedicated traffic channel (DTCH) throughput test found in the **Func** menu. The other option is **Fixed MAC padding**, as illustrated in Figure 5. This option will pad transport blocks with random data unless real data is available, and therefore fully load the PRBs specified. The receiving MAC layer is able to determine what is real and what is padded data, and it discards the padded data (this could be the entire PRB). If no other data-generating entities are running, the UE will discard all the received data and send only acknowledgements (ACKs) from the layers below the Medium Access Control MAC layer. This is a nice feature because it reduces power consumption from transmitting ACKs on the reverse link.

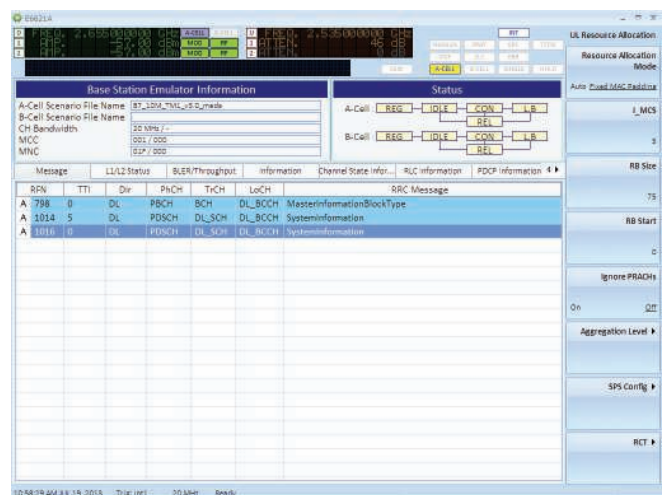

Figure 5. UL resource allocation menu

When you have finished adjusting the PHY-layer settings, the next task is to adjust the Radio Resource Control (RRC) settings. The **RRC Settings** menu include maximum transmit power level (p-Max) and default paging cycle, as illustrated in Figure 6. Furthermore the **RRC Settings** menu has a **DRX Settings** submenu that lets you adjust the aforementioned DRX parameters including period length and inactivity and on duration timers.

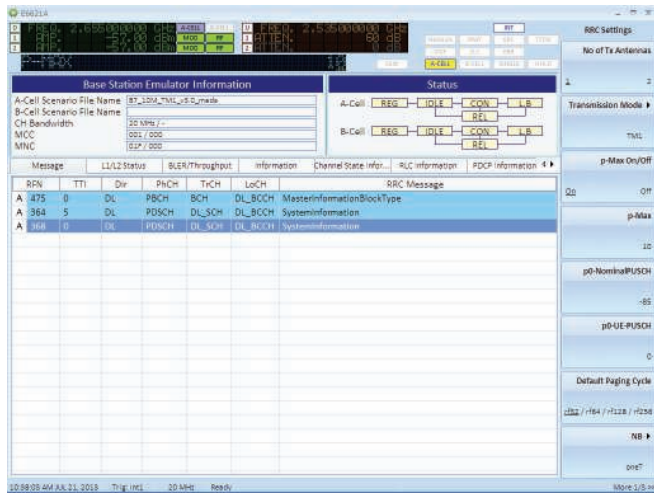

Figure 6. RRC settings menu

Keep the maximum transmit power as low as possible in all test cases except number 6 because the power amplifier has a major impact on power consumption. Because the UE transmits a low-power signal, be sure to set the RF1 attenuation accordingly using the **Atten** button.

The final settings you need to adjust are the RF1 and RF2 amplitude settings. In this menu, you can set the UE receive power in dBm, which is specified to a fairly high level in all test cases, except for number 3. To minimize the power consumption impact, the UE RF should use gain settings as low as possible .

### Step 3: Initiating the measurement

After the phone is powered on, close programs, make sure other radios such as WiFi and **Bluetooth**® radios are off, and finally, turn the screen off or use a specified brightness level. Then set the PXT **Emulator Mode** to **Run**. You will notice that some parts of the **PHY** and **RRC Settings** menus become grayed out, so these parameters cannot be changed during run time. The status window of the PXT should change to “con” (connected), as illustrated in Figure 8. Now you can start the test. In all the test cases in Table 1, the tests are initiated by applying the MAC padding, to ensure the UE is active, and then running the N6705B data logger as explained in the next section.

### Step 4: Run the N6705B data logger and note important PXT values

When the UE e.g. has started receiving data as specified in test case 1, begin logging the power consumption using the N6705B by pressing the **Run/stop** button. When you are finished logging data, the N6705B screen should look similar to Figure 7.

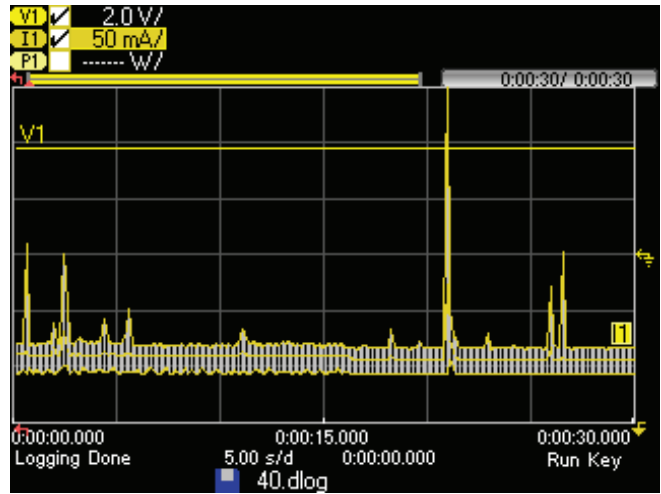

Figure 7. Screen shot of data log window. Notice the 30 s duration in the upper right corner and the file name in the lower middle

Next, export the logged data from the N6705B to a USB stick. To export data, select **File > Export**. To store a comma-separated file on the USB stick, select **Export logged data (.csv)**.

At this time it is also important to note the relevant PXT parameters according to the given test case. If data rate is of interest, you can run the DTCH throughput test, because it reports the achieved data rate, as illustrated in Figure 8.

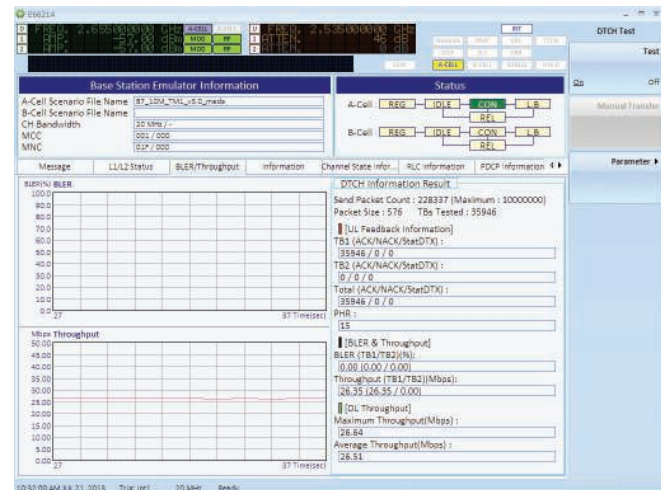

Figure 8. DTCH throughput test



If the transmit power level is important, you can check the power level received by the PXT. This value is available in several PXT submenus, including the **LTE UL demodulation** menu, as illustrated in Figure 9.

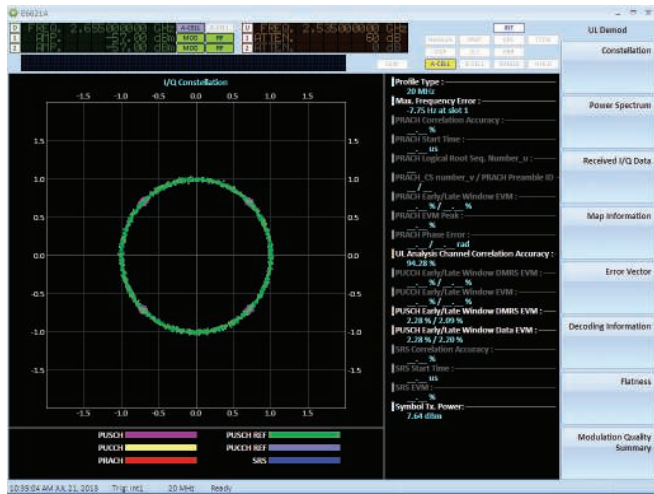

Figure 9. Demodulation of uplink signal. Notice the symbol transmit power is reported in the lower right corner.

## Results/measurement data

When you have collected the relevant parameters from the PXT and N6705B, you can post-process them to generate the model illustrated in Figure 1. Each test case provides input for one UE component, and an example of such a combination is given in Figure 10, where the downlink data rate, which was controlled and measured using the PXT, has been combined with the supply power consumption measured by the N6705B.

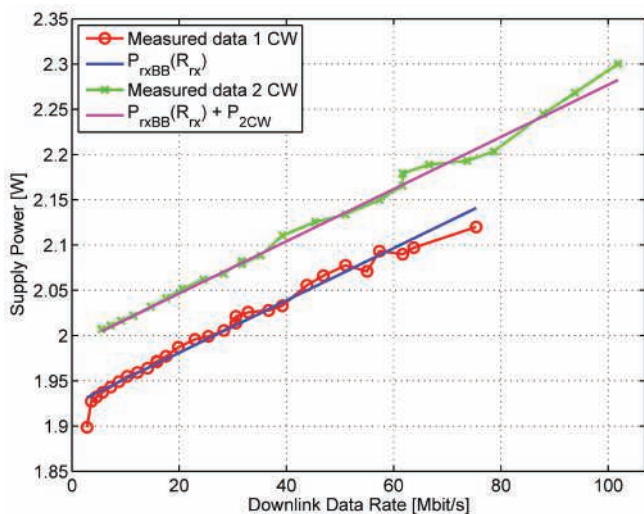

Figure 10. Supply power consumption as a function of downlink data rate. Figure 3 in [7]

Next, calculate a polynomial fit to the data, as shown in the  $P_{rxBB}(R_x)$  line in Figure 10. Then insert the polynomial function in the appropriate part of the power consumption model.

Two articles discuss using the PXT and N6705B setup. In *LTE UE Power Consumption Model - For System Level Energy and Performance Optimization* [7], the authors discuss the basis for the model in Figure 1 and report power consumption for commercial LTE dongles. The article mentioned earlier [2] is an updated version of this paper [7], and it includes measurements on first-generation LTE smartphones and examines screen and DRX power consumption. Refer to the papers for further details on measurement setup and results.

## Number of test points per test case

The number of test points required to reproduce the results was discussed in the article [2]. The discussion is repeated here because the number of test points has a huge effect on overall test time and that influences the possibility of keeping the model up to date by making measurements on new UEs.

Test case 1 includes 29 points, but when you examine Figure 10 it is clear that the power consumption is almost a linear function of downlink data rate. Therefore, three test points should be sufficient. The same goes for test case 2, which could be omitted completely.

Test case 3 is designed to study Rx RF power consumption as a function of receive power level. The results reported in the articles [2, 7] show two to three power steps, which are caused by adjustments in the low-noise amplifiers. Therefore, five to six points are required.

Power consumption as a function of transmit data rate is studied using test case 4. You can see that the power is almost independent of the encoding rate and changes only when the modulation scheme is changed from QPSK to 16QAM. Because the standard specifies when the modulation changes, the test case could be performed using four points, where two of them are located around the modulation change.

The final test case is used to examine the Tx RF, which is the most power-consuming component. The behavior is UE specific, especially for transmit powers above 0 dBm, and therefore a very complete set of test points (for example, with 1 dB steps) is needed. It is important to note that different power amplifiers are used for different frequency bands, as pointed out in the article *LTE Power Model* [8].

## Uncertainties

The measurement setup includes uncertainties, some of which are listed below:

- Because supply power is measured, it is not possible to separate the contributions from each of the components in the model. If you carefully design the test cases, however, you can minimize the undesired contributions. Furthermore, other UE peripherals such as the screen and the CPU also contribute.
- The measurements are not conducted over the air, as would be the case in real life. Because real antennas are lossy, the power consumption in real life will probably be a bit higher. It may, however, only have a very minor effect on the relative accuracy between the model's components.
- The temperature of the UE has an impact on power consumption. The optimal method would be to ensure the same UE test temperature at each measurement, but this would require either time-consuming cool-down periods or some type of warm-up procedure.
- Some UEs have sophisticated power management chips that continuously adjust specific components. These continuous changes and the temperature issue make repeatability difficult to achieve.
- A careful calibration of the PXT-UE cables is required.

## Conclusion

In this application note we showed you how to measure smartphone power consumption as a function of relevant network parameters with the Keysight PXT and the Keysight N6705B with the N6781A SMU module installed.

The measurements are useful to both chipset manufacturers and mobile network operators, because they can help estimate the smartphone's battery life, which is a key performance indicator for the user.

We offered a list of relevant test cases for developing a smartphone power model and discussed how many measurements point are needed to repeat and update the model. We also explored some measurement uncertainties.

Thank you to Mads Lauridsen, Aalborg University for writing this application note.

Thanks to Janus Faaborg, Keysight Technologies Denmark for supporting this work.

This project was partly funded by the 4GMCT project.

## References

1. *Third Generation Partnership Project (3GPP)*. 2013. Long Term Evolution <http://3gpp.org/lte>
2. Lauridsen, Mads et al. *Empirical LTE Smartphone Power Model with DRX Operation for System Level Simulations*. VTC Fall 2013.
3. Keysight Technologies. May 2013. *Keysight PXT Wireless Communications Test Set (E6621A) User's Guide v.6.5*
4. Keysight Technologies. June 2012. *Keysight N6700 Modular Power System Family*
5. Keysight Technologies. March 2011. *Evaluating Battery Run-Down with the N6781A 2-Quadrant Source/Measure Unit and the 14585A Control and Analysis Software*
6. 3GPP. 2010. *MAC protocol specification, TS 36.321 V8.9.0*.
7. Jensen, Anders R. et al. *LTE UE Power Consumption Model - For System Level Energy and Performance Optimization*. VTC Fall 2012
8. Dusza, Björn et al. 2013. *LTE Power Model*. <http://www.kn.e-technik.tu-dortmund.de/en/forschung/lte-ue-power-model.html>

**myKeysight**

**myKeysight**

[www.keysight.com/find/mykeysight](http://www.keysight.com/find/mykeysight)

A personalized view into the information most relevant to you.

**Three-Year Warranty**

[www.keysight.com/find/ThreeYearWarranty](http://www.keysight.com/find/ThreeYearWarranty)

Keysight's commitment to superior product quality and lower total cost of ownership. The only test and measurement company with three-year warranty standard on all instruments, worldwide.

**Keysight Channel Partners**

[www.keysight.com/find/channelpartners](http://www.keysight.com/find/channelpartners)

Get the best of both worlds: Keysight's measurement expertise and product breadth, combined with channel partner convenience.

*Bluetooth* and the Bluetooth logos are trademarks owned by Bluetooth SIG, Inc., U.S.A. and licensed to Keysight Technologies, Inc.

[www.keysight.com/find/N6705B](http://www.keysight.com/find/N6705B)



For more information on Keysight Technologies' products, applications or services, please contact your local Keysight office. The complete list is available at: [www.keysight.com/find/contactus](http://www.keysight.com/find/contactus)

**Americas**

|               |                  |
|---------------|------------------|
| Canada        | (877) 894 4414   |
| Brazil        | 55 11 3351 7010  |
| Mexico        | 001 800 254 2440 |
| United States | (800) 829 4444   |

**Asia Pacific**

|                    |                |
|--------------------|----------------|
| Australia          | 1 800 629 485  |
| China              | 800 810 0189   |
| Hong Kong          | 800 938 693    |
| India              | 1 800 112 929  |
| Japan              | 0120 (421) 345 |
| Korea              | 080 769 0800   |
| Malaysia           | 1 800 888 848  |
| Singapore          | 1 800 375 8100 |
| Taiwan             | 0800 047 866   |
| Other AP Countries | (65) 6375 8100 |

**Europe & Middle East**

|                |               |
|----------------|---------------|
| Austria        | 0800 001122   |
| Belgium        | 0800 58580    |
| Finland        | 0800 523252   |
| France         | 0805 980333   |
| Germany        | 0800 6270999  |
| Ireland        | 1800 832700   |
| Israel         | 1 809 343051  |
| Italy          | 800 599100    |
| Luxembourg     | +32 800 58580 |
| Netherlands    | 0800 0233200  |
| Russia         | 8800 5009286  |
| Spain          | 800 000154    |
| Sweden         | 0200 882255   |
| Switzerland    | 0800 805353   |
|                | Opt. 1 (DE)   |
|                | Opt. 2 (FR)   |
|                | Opt. 3 (IT)   |
| United Kingdom | 0800 0260637  |

For other unlisted countries:  
[www.keysight.com/find/contactus](http://www.keysight.com/find/contactus)  
 (BP-09-23-14)